



**TECHNICAL GUIDE**  
**1635X3230 mm**

6 - 12 - 20 mm



**MA  
TER  
IA**<sup>TM</sup>



# CUTTING AND INSTALLATION INDICATIONS

Introduction	2
Surface appearance, slab flatness and label	3
Slab storage	4
Cutting suggestions	5
Cutting with water jet	7
Disk cutting using bridge milling	8
Drilling	9
Disk cutting patterns	10
Cutting and machining with CNC machine (contouring machine)	11
Circular and quadrangular holes, flush holes	12
Cutting operations	13
Cutting patterns for cutouts, Machining with numerical control	18
Machining the edges	19
Installation and supports	20
Protruding parts and overhangs	21
Coplanar slabs	22
Slabs Transport	23
45° Joint	23
Sinks	24

# MAINTENANCE AND UPKEEP

Cleaning after installation	25
Extraordinary cleaning	25
Technical characteristics	26
Comparison table	27
Packaging	28-29

# Foreword

The MATERIA surfaces, made with high quality raw materials, dry compaction technique sand firing in latest generation ceramic kilns, lend themselves well for use even in the most extreme settings due to their high resistance. In addition to the possibility of installation in damp and outdoor environments, MATERIA slabs are perfect for creating kitchen countertops, thanks to its parameters of resistance to impact, scratches and heat, as well as those that measure the vulnerability to attacks by chemical agents. This is why MATERIA, even in the worktop setting, is a choice that perfectly combines style and practicality.

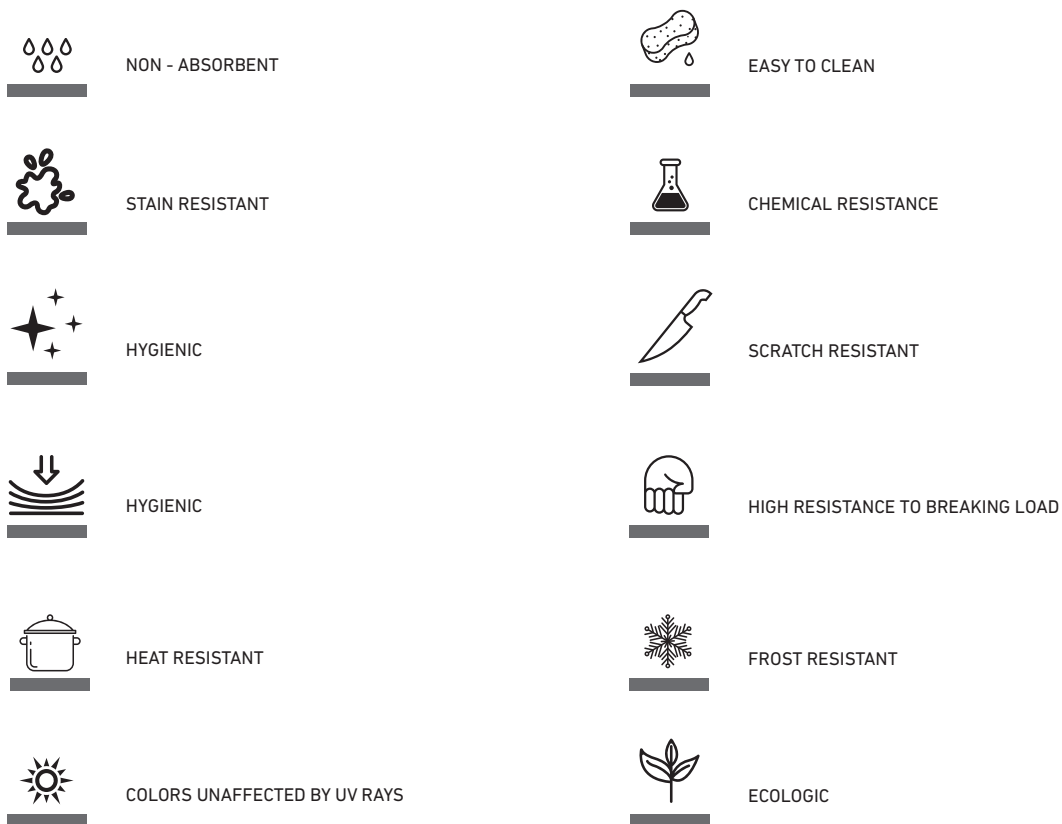

# Surface appearance

The selection of raw materials and state-of-the-art technological procedures allow the production of slabs with excellent quality standards. However, some occurrences are possible and fall within the acceptability of the product:

Occasional impurities on the slab and of modest size.

Dots of color in contrast or in line with the graphics approximately 2 mm.

Relief lumps in general with a low contrast of color indicatively 3 mm in diameter.

Slight depressions and regular/irregular micro-holes of approximately 2 mm in size.

The above do not alter the quality and characteristics of the product and are occasionally visible on the surface, rarely repeated on the same plate. In case of clear defects, the slab must not be handled unless authorized by the Producer.

# Slab flatness

It is possible to determine whether a slab is concave or convex through a perfectly even and horizontal support plane by placing a linear bracket on the slab with the tolerances indicated in the diagram. Flatness checks carried out with vertical slabs are not reliable for an assessment of the lack of flatness.

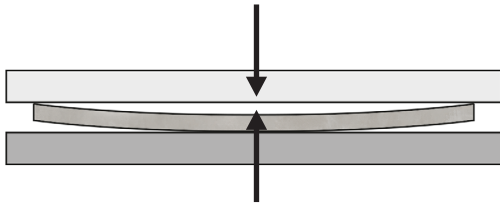

	Length	Width
Tolerance	$\pm 2$ mm	$\pm 4$ mm

# Label

The Label allows to have production traceability with indications of the Production Lot, Tone and Choice. Keeping the Label can be useful in case of completions and/or integrations for the verification of the Tone/Color. However, slight color differences are possible even within the same Lot and Color Tone. The Label is also essential for reporting any criticalities detected and will be needed along with the additional documentation when filing the Report Form.

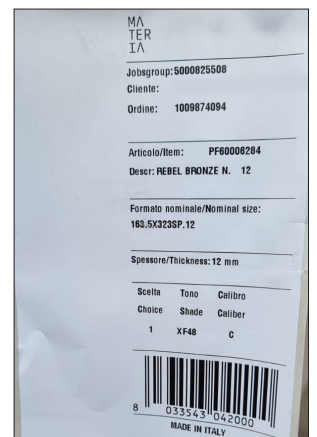

# Slabs storage

The slabs can be stored on A-frame or traditional racks for stone and quartz material. The recommendation, for the safety of both slabs and operators, is to check that the slabs are held with belts and protections. It is recommended to apply wooden, rubber or plastic protections on the racks in order to avoid breakages and chipping. Sometimes the racks have support columns towards the inside of the slab, for this reason the most extreme parts of the slab do not find support on the columns and this leads to a natural curvature that generally disappears when positioning the slab on the workbench. However, as it is not possible to know how long the slab will remain with no back complete support, in order to avoid an accentuated curvature which could become hard to return to planarity, it is recommended to use racks for ceramic slabs that allow a complete support of the slab; an alternative is to use a granite or marble slab (do not use wooden ones) with larger dimensions on which to place the ceramic slabs so as to guarantee the tightness even for a prolonged time, facilitating the workability of the slab.

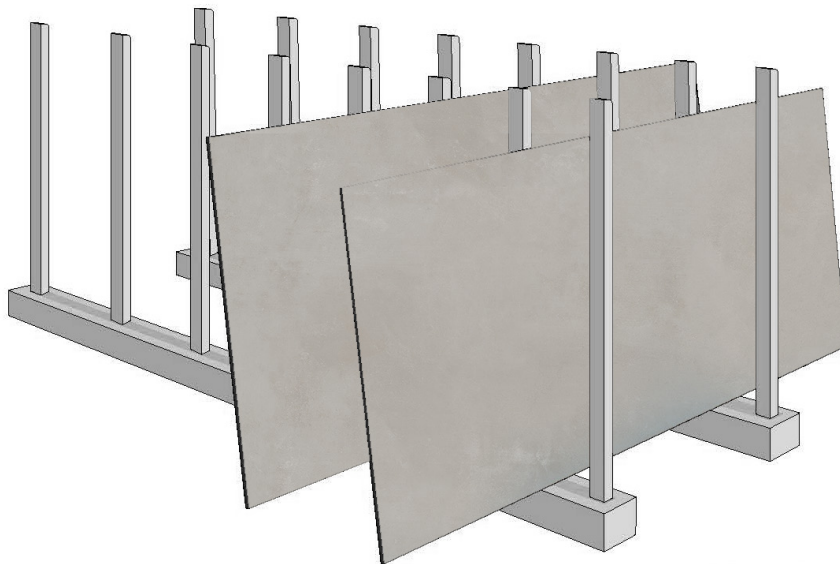

We also remind to place the cutout pieces in front of the entire slabs in order to avoid imbalances of the support both vertically and horizontally: larger dimensions behind and lower ones in front.

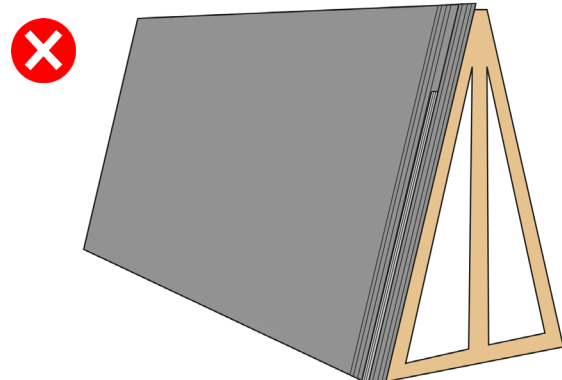
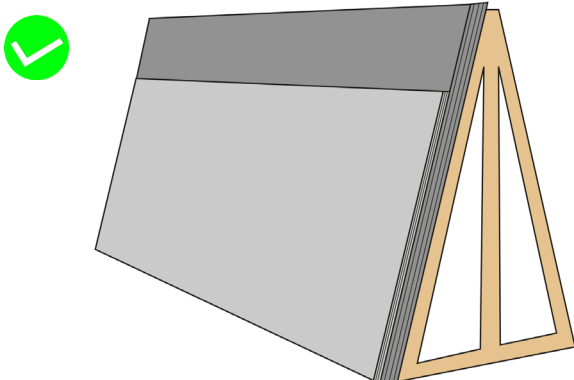

# Cutting suggestions

The MATERIA slabs can be cut and machined on traditional cutting machines for natural stone, marble and quartz agglomerations such as bridge milling and CNC machines, CNC contouring machines and waterjet machines.

In the case of machining using a tool, it must be suitable for cutting 6-12-20 mm porcelain stoneware. Information and parameters are provided in this manual for cutting on: Waterjet machine-Bridge and CNC milling machines-CNC Contouring machines.

In order to achieve optimum machining, it is good standard practice to verify the perfect flatness of the work table/grid plate on which the slab will be placed, as well as the absence of scraps and debris from previous operations.

The flatness of the work table/grid plate, combined with that of the slab, is important for the good quality of the cut because it reduces vibrations.

Before carrying out any type of machining on the slab, MATERIA always recommends doing a trimming cut.

The trimming cut consists in cutting 1 cm more than the thickness of the material being machined on a long side and a short side; cutting on all 4 sides is recommended.

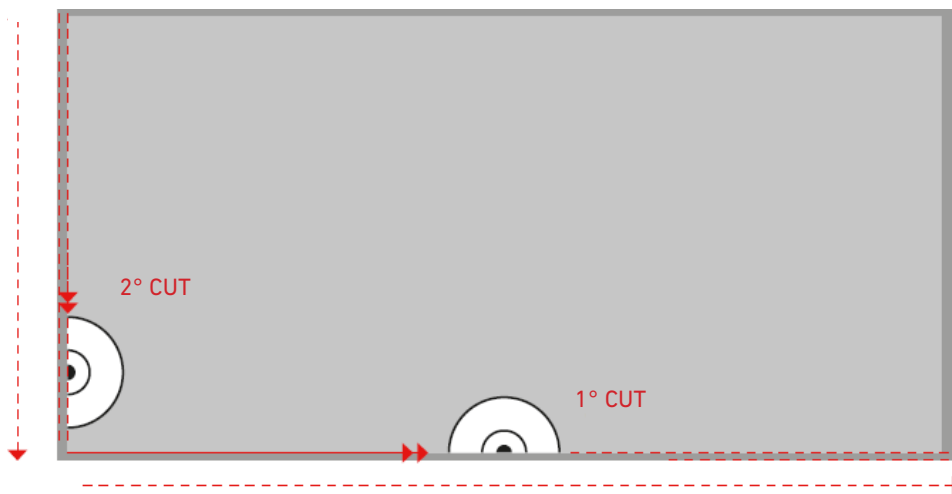

In drilling holes and making internal cuts, MATERIA recommends leaving no less than 5 cm between two adjacent cuts/holes and between a cut/hole and the edge of the slab itself.

Moreover, in carrying out quadrangular holes, MATERIA advises against carrying out 90° angles.

Set out a radius in correspondence to these corners, with radius of curvature greater than or equal to 5 mm. If the geometry of the hole allows, use wider radii (8-10 mm).

In any case, as a general rule, you should remember that the sturdiness of the finished surface increases with the increase of the internal radius of curvature of the holes and with the increase of the distance between two adjacent cuts. Surfaces with large holes are intrinsically more delicate.

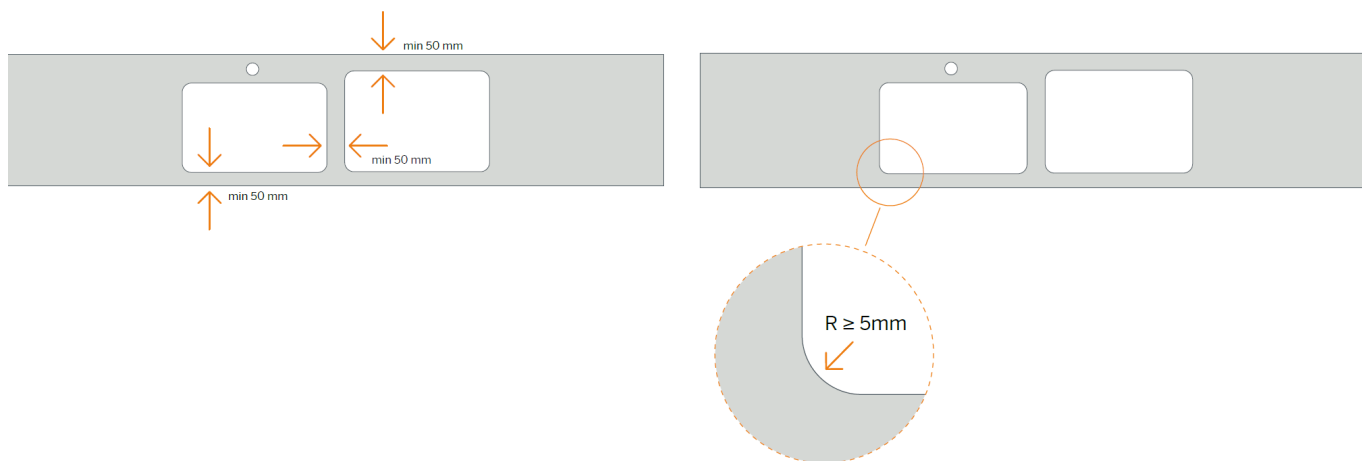

If possible, carry out the holes on the surface in the portion of material closest to the centre of the original slab.



In the event of "L" shaped kitchen countertops, provide a wide radius on the internal corner.

Nevertheless, for greater sturdiness of the surface, we recommend dividing the piece into two parts.

In this case, we recommend studying the most suitable cutting scheme for the aesthetics of the composition.

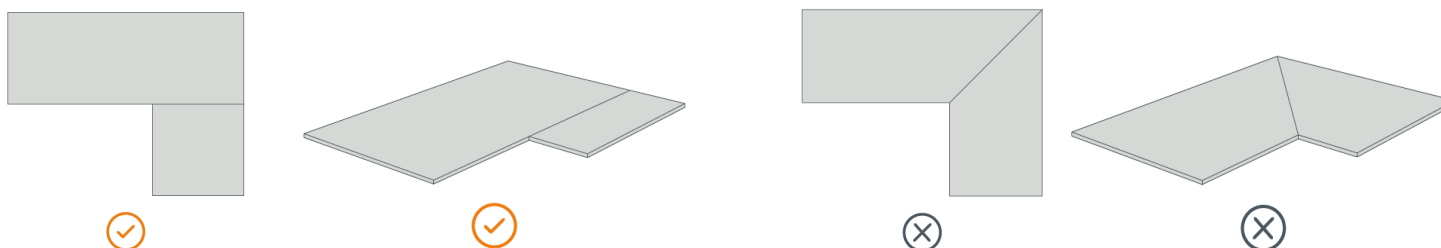

At the end of each cutting operation, it is advisable to rinse the slab with abundant water jets in order to remove debris, dust or abrasives consumed during the machining.



# Cutting with water jet

In creating surfaces using waterjet machines, MATERIA recommends carrying out the operations in the following sequence:

- **Trimming cuts**
- **Any internal holes**

In carrying out internal holes, we recommend beginning the cut from a point inside the perimeter of the hole (at least 2 cm, if possible) and then proceed toward the perimeter with a curved trajectory (curled).

Once the cut is complete, we also recommend removing the nozzle with a curved trajectory, toward the inside of the hole.

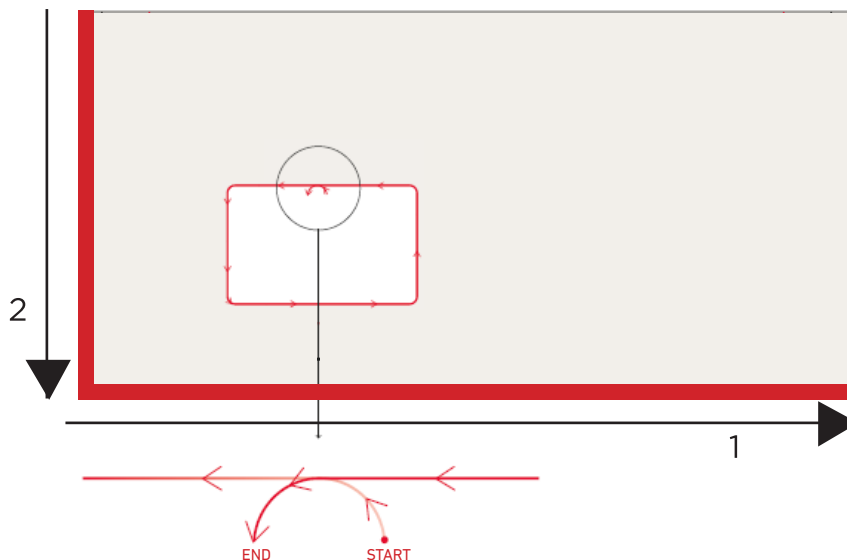

MATERIA recommends a nozzle feed rate of 1000-1500 mm/min for straight perimeter cuts and a feed rate of 500-800 mm/min to carry out internal holes. The pressure of the jet must be between 3000 and 3500 bar and the abrasive consumption about 0.35 kg/min. In the event of carrying out internal holes, we recommend reducing the jet entrance pressure to 600-800 bar, to then increase to 3000-3500 when the jet has completely penetrated inside the thickness.

Should the machine allow 45° waterjet cutting, we recommend a feed rate equal to half of the feed rate used for straight cuts.

# Disk cutting with bridge milling machine

In carrying out surfaces using bridge milling cutters, we recommend carrying out the operations in the following sequence:

## - Trimming cuts

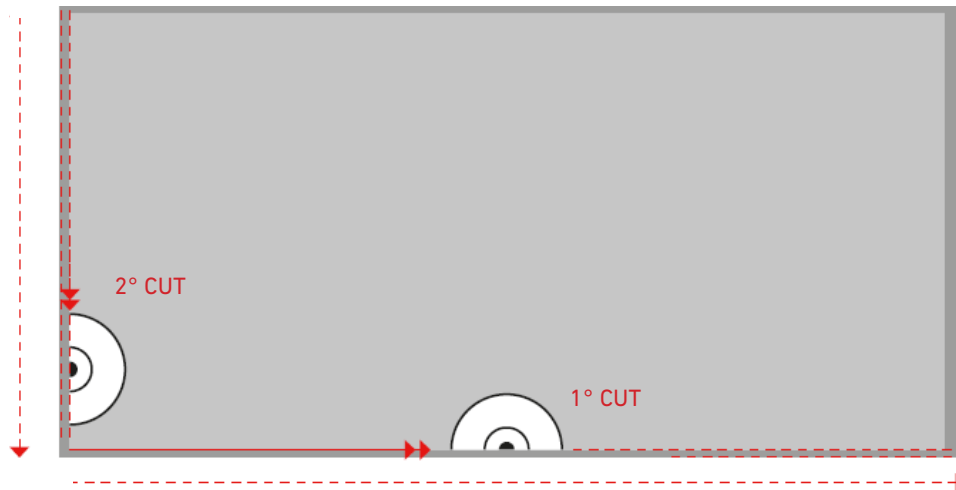

MATERIA recommends using specific diamond disks for porcelain stoneware and 6-12-20 mm thickness. Diamond disks for granite (soft, hard), marble and quartz agglomerations are not suitable for cutting ABK GROUP porcelain stoneware. For this type of cut, we recommend using sectored or resin diamond disks. Disk cutting on bridge milling machines must be carried out damp, ensuring an abundant jet of water directed precisely at the cutting area, from both the front and the side. The rotation direction of the disk must be consistent with the feed direction of the same. MATERIA recommends using diamond disks with 30- 35- 40 cm diameter depending on the machine used, ideal for cutting a thickness of 6- 12- 20 mm. The rotation speed depends on the diameter of the disk. The ideal tangential speed of the crown is generally about 40-45 m/s.

DIAMETER (MM)	ROTATION SPEED (RPM)
300	2100-2300
350	1600-1800
400	1400-1600

For the optimum parameters calibrated on the single disk, please see the manufacturer's technical data sheet.

The optimum feed rate of the sectored disk is 1200-1600 mm/min (6-12-20mm) for linear straight cuts, whereas in the event of a 45° cut, it must be reduced by 40%. For linear cuts using a resin disk, the speed of 2500 mm/min is reached. In the case of a 45° cut, it is important to reduce the feed rate of the disk because it is subject to greater vibrations.

In order to reduce the vibrations in the cutting phase (linear and inclined), it is important that the optimum feed rate is reached with the entire disk is completely inside the material, not just entering, but also, and above all, when exiting. For this purpose, should the machine allow it, MATERIA recommends reducing the feed rate by 50% until the disk is completely inside the material.

This distance therefore depends on the diameter of the disk.

It is important that the disk descends below the level of the slab by 1-2 mm so that the cooling water can also evacuate from below.

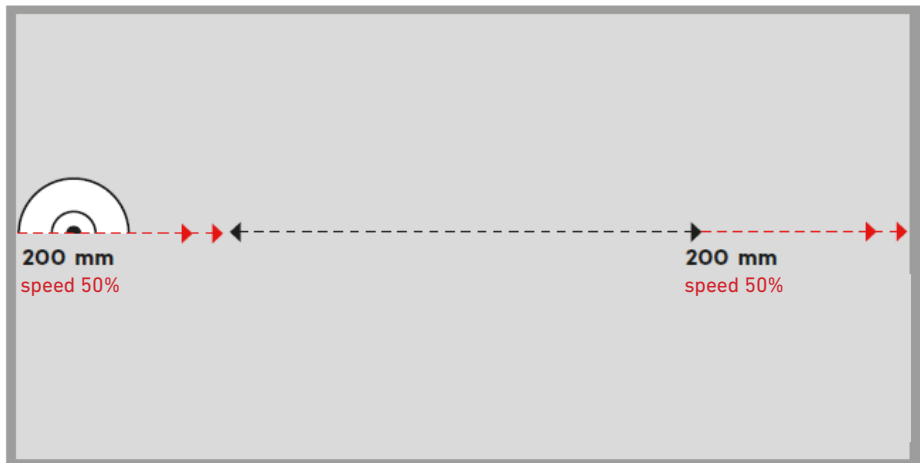

As support material for the slab during the cut, MATERIA recommends specifically designed vulcanised rubber sheets, expanded polymer material (XPS), slabs of granite or quartz agglomerations.

We recommend against using marine plywood sheets because they absorb water and can be deformed.

Should the diamond of the disk be dirty, we recommend sharpening it by cutting open sandstone sheets, quartz agglomeration slabs, sand/cement based bricks or sharpening stones sold for this specific operation.

If the work table allows, a strip of abrasive material can be provided up against the slab being cut so that the disk follows its travel post-cut, cutting into the abrasive material and sharpening itself.

## Hole drilling

Once the perimeter cut in the bridge milling machine has been carried out, MATERIA recommends against using the bridge milling machine to carry out the internal rectangular holes as well. To carry out the holes, a waterjet or CNC contouring machine must be used.

# Cutting scheme

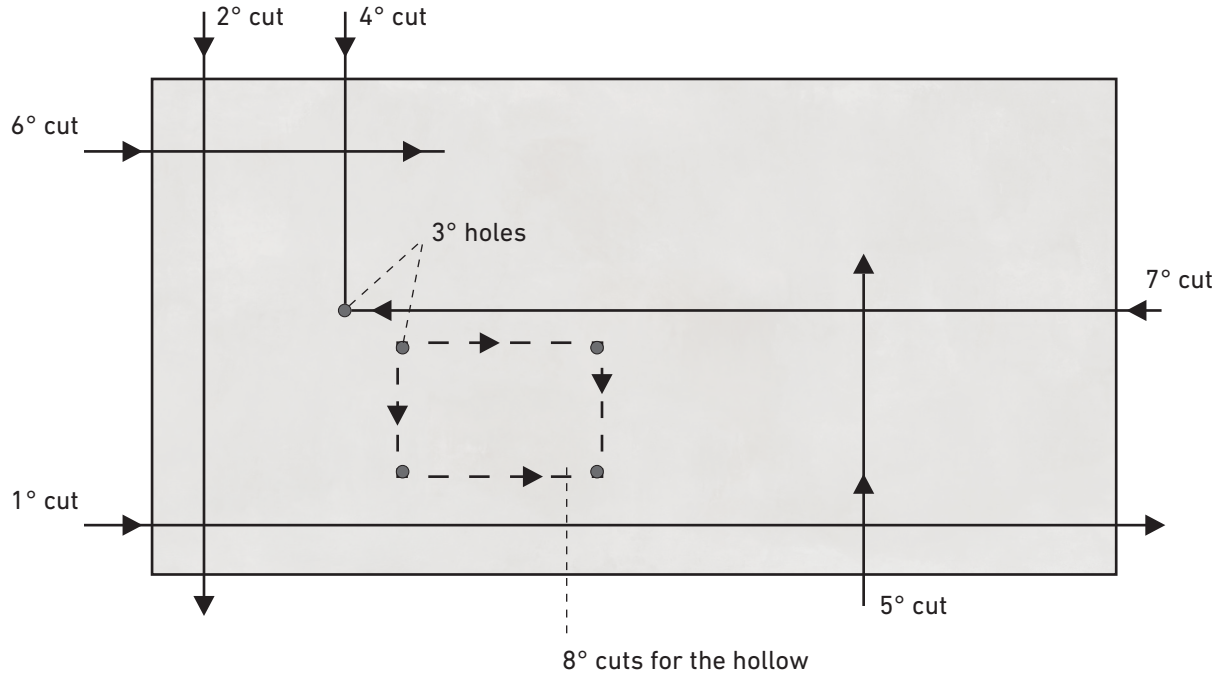
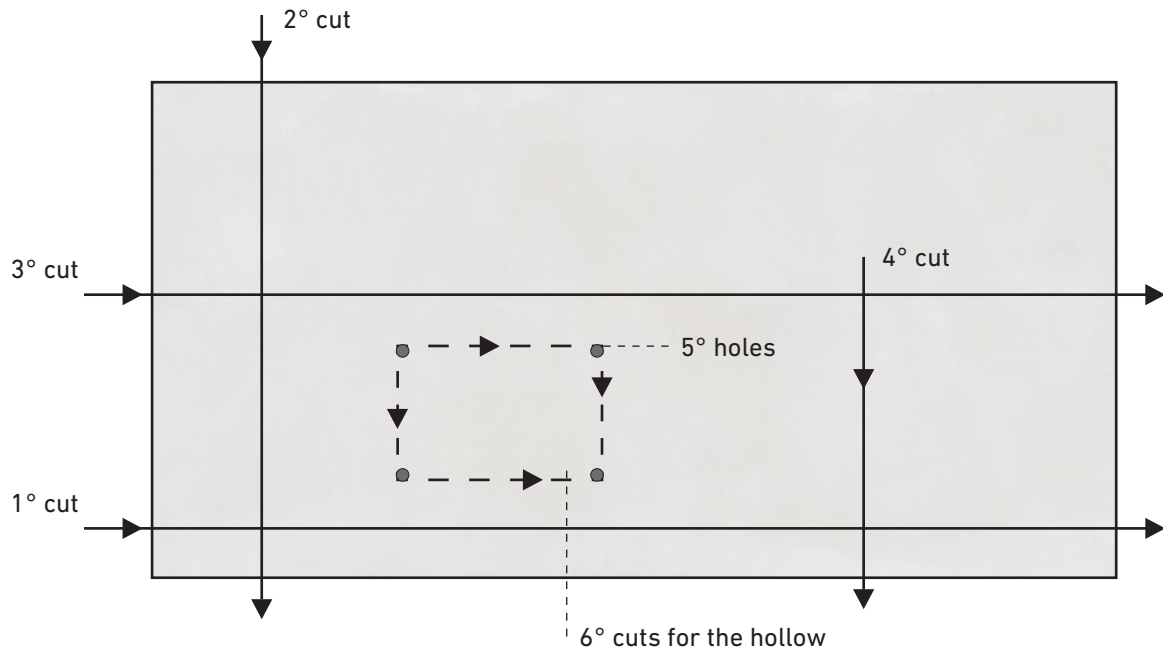

# Cutting and machining with CNC machine (contouring machine)

In the case of carrying out machining, cuts and holes using CNC contouring machines, arranging suction cups on the bottom part of the slab is indispensable. The suction cups must be distributed evenly under the slab in such a way so as to reduce vibration and bending during the cutting operations. In the case of carrying out holes and cuts of portions of material, the suction cup(s) must be positioned in the area of the cut material so that it is supported and it does not fall at the end of the cut.

Ensure that the suction cups have a perfect grip on the back of the slab.

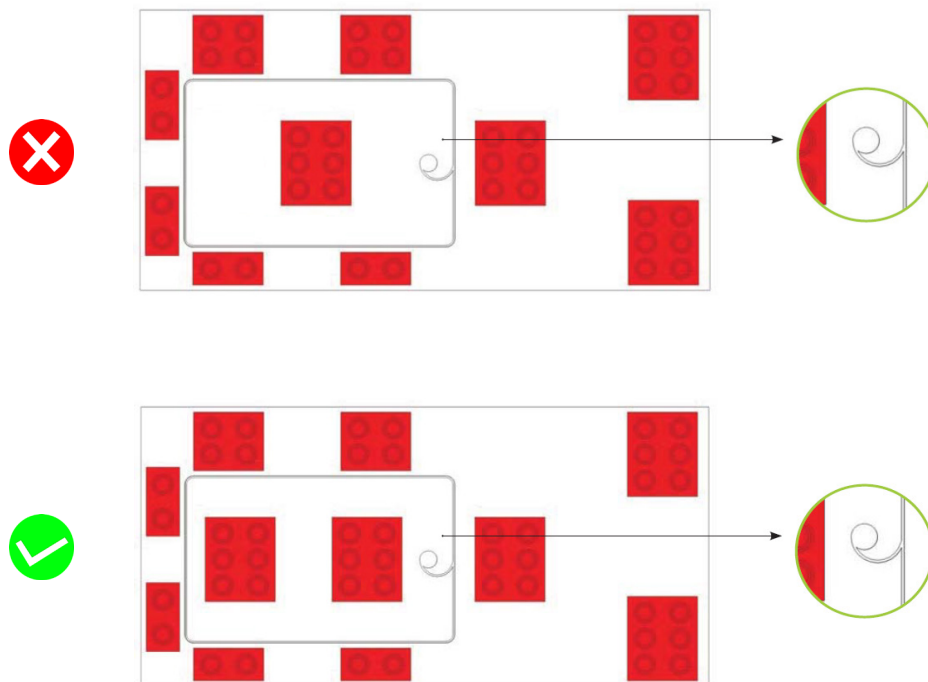

## Circular holes

The circular holes, both those which will house the mixer tap and those made ahead of time in the corners of the quadrangular holes, are carried out damp using diamond drill bits.

Provide abundant water flow both inside and outside the cutting circumference.

Router bits of all diameters are available on the market. The recommended rotation speeds range from 1800 to 3000 RPM, depending on the diameter of the router bit, with a feed rate in the thickness of 20-30 mm/min.

If the machine allows, for the 2 mm entering and 2 mm exiting, it is good practice for the router to have a lower feed rate of about 5 mm/min\*.

This way, the risk of chipping on the lower part of the slab is minimised.

# Quadrangular holes

In the CNC machine it is possible to carry out the quadrangular holes by means of the technique of boring in the corners using a diamond router bit (remembering the general radius indications) and then carrying out the cut using a diamond mill cutter.

In this case, a circular hole is carried out ahead of time using a diamond router bit inside the perimeter of the quadrangular hole. If possible, this circular hole must be carried out at the centre of the quadrangular hole at the greatest possible distance from the perimeter of the hole.

The diamond mill cutter, smaller in diameter than the circular hole, enters into the hole that has just been bored and moves toward the perimeter of the quadrangular hole with a broad circular trajectory, proceeding with the cut. The typical feed rate for this type of operation is 200-300 mm/min, with a rotation speed of 4500-5000 RPM.

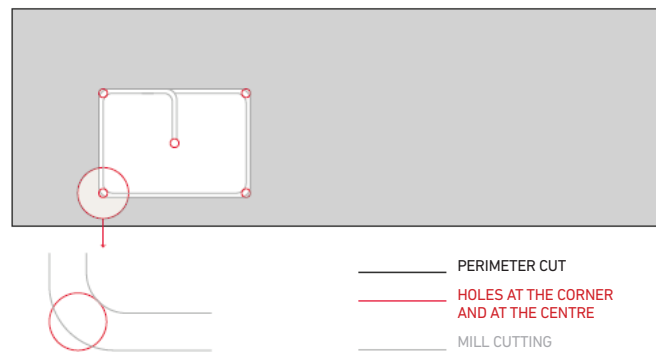

It is preferable for the mill cutter to move in such a way so as not to touch the corners of the hole, where the circular holes have been made: this way applying pressure on the corner is avoided.

# Flush hole

In the case of carrying out a hole with flush hole recessing, MATERIA recommends carrying out the recess before the actual hole. The recess is carried out using a mill cutter capable of removing material from the lower surface as well. Generally, the mill cutter is unable to remove all the material in a single pass. Repeat the passes until reaching the desired recess depth: MATERIA recommends against using recesses greater than half the thickness of the slab.

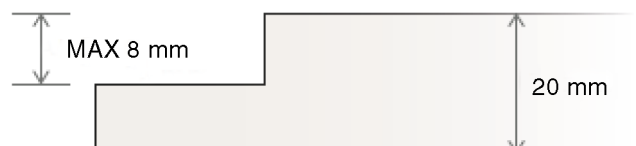
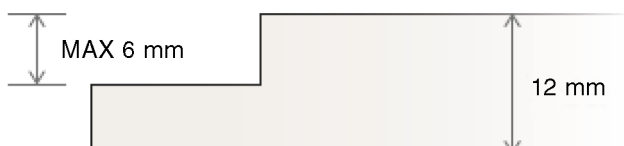

28 November 2019 and 13 February 2020 machining tests

**MATERIAL:**

3200 X 1600 mm nominal      thickness 12/20 mm

Prove realizzate in collaborazione con



**CUTTING OPERATIONS WITH DISK**

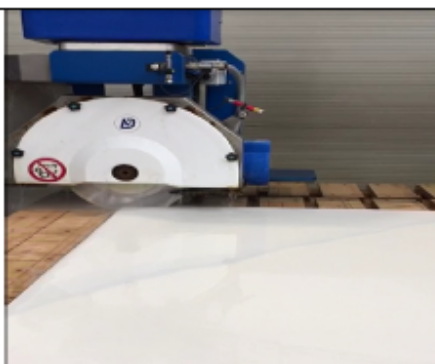

**Rifilatura lastra  
e ricavo pezzi per piano  
cucina**

Macchina:

**Donatoni Echo**

**VERTICAL CUT WITH SECTORED DISK**



RPM	FEED [mm/min]
1500	1000 - 1200

ADI CODE	DESCRIPTION
MTS64034	Sectored metal disk Ø 400X3,4X10 BORE 60 mm <b>COMPACT ITALO</b>
MTS64035	Sectored metal disk Ø 400X3,4X10 BORE 50 mm <b>COMPACT ITALO</b>

## CUT WITH HIGH PERFORMANCE SECTORED DISK

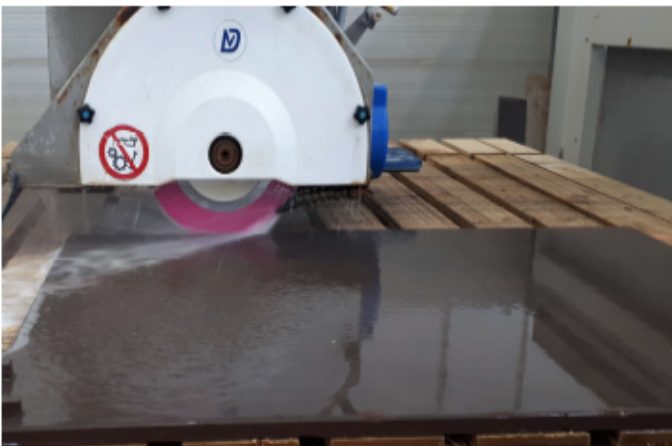
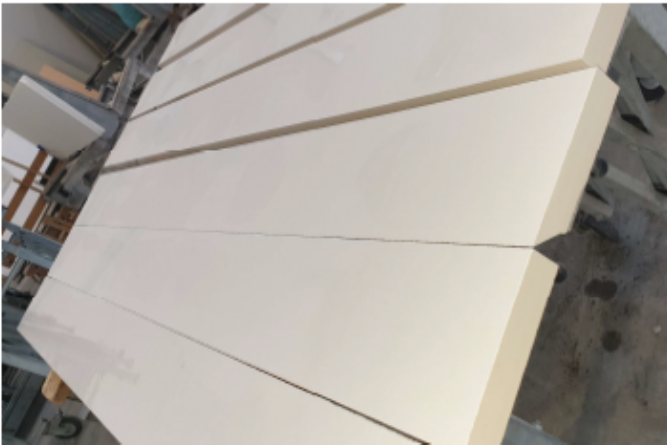

<i>RPM</i>	<i>FEED</i> [mm/min]
1450 - 2000	1000 - 1500

ADI CODE	DESCRIPTION
MTA64012	Sectored metal disk Ø 400X3,5X7 FORO 50 mm <b>COMPACT RATIO</b>
MTA64013	Sectored metal disk Ø 400X3,5X7 FORO 60 mm <b>COMPACT RATIO</b>



## VERTICAL CUT WITH RESIN DISK



<i>RPM</i>	<i>Avanzamento</i> [mm/min]
2200	1000 - 2000

ADI CODE	DESCRIPTION	
CA02202	Resin metal disk <span style="background-color: yellow;">Ø 350X2,6X 8,5</span> <span style="background-color: yellow;">Bore 50 mm</span> <b>COMPACT AMBRA</b>	
CA02203	Resin metal disk <span style="background-color: yellow;">Ø 350X2,6X 8,5</span> <span style="background-color: yellow;">Bore 60 mm</span> <b>COMPACT AMBRA</b>	

<i>RPM</i>	<i>Avanzamento</i> [mm/min]
1800	1000 - 2000

ADI CODE	DESCRIPTION	
CA02205	Resin metal disk <span style="background-color: yellow;">Ø 400X2,6X 8,5</span> <span style="background-color: yellow;">Bore 50 mm</span> <b>COMPACT AMBRA</b>	
CA02206	Resin metal disk <span style="background-color: yellow;">Ø 400X2,6X 8,5</span> <span style="background-color: yellow;">Bore 60 mm</span> <b>COMPACT AMBRA</b>	



## CUTTING OPERATION WITH WATERJET CUTTING

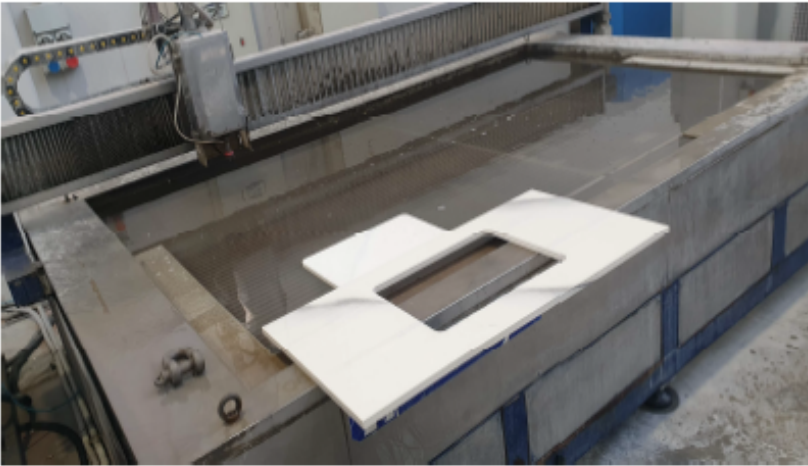

Sink internal cut for  
kitchen countertop

Machine:  
Waterjet

Feed rate 800 mm/min

## LAVORAZIONI CON CONTROLLO NUMERICO



Sink internal boring for  
kitchen countertop

Machine:  
Breton NC 300

ADI CODE	Description	RPM	FEED [mm/min]
MT81135	Router Ø 35	1800	30

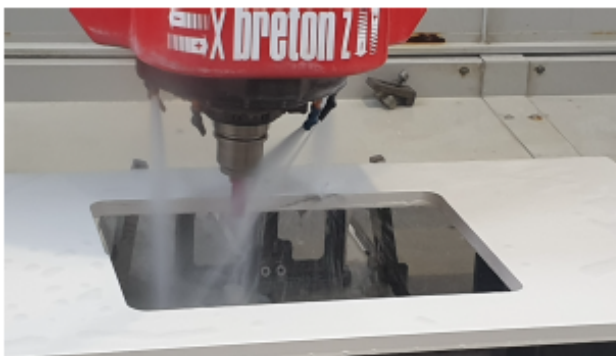

Kitchen countertop  
sink size cut

Machine:  
Breton NC 300

ADI CODE	Description	RPM	FEED [mm/min]
MT74030	Sectored milling machine Ø 22	4500	300



Kitchen  
countertop  
internal /  
external profiling

Machine:  
Breton NC 300

ADI CODE	Description	RPM	FEED mm/min
MT90016	∅ 20 profile milling cutter Position 1	6000	400
MT90017	∅ 20 profile milling cutter Position 2	6000	1000
MT90018	∅ 20 profile milling cutter Position 3	6000	1000
MT90019	∅ 20 profile milling cutter Position 4	5800	800

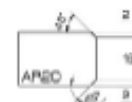

Flush machining  
for sink  
mounting

Machine:  
Breton NC 300

ADI CODE	Description	RPM	FEED [mm/min]
MT75022	Continuous mill cutter with grooves ∅ 16	5500	1000

Removal 2 mm

NOTE: The work parameters used are conservative.

## Cutting scheme

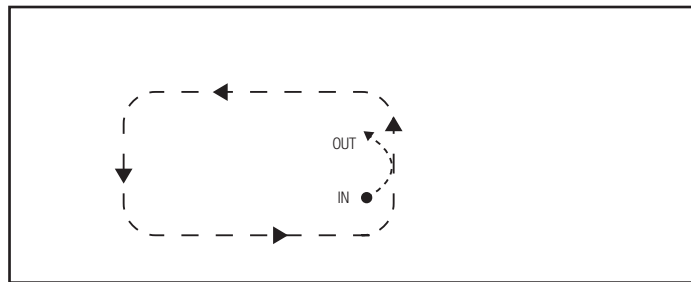
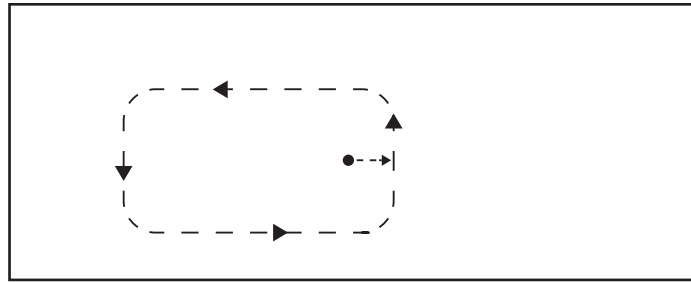

## Numerical control processing

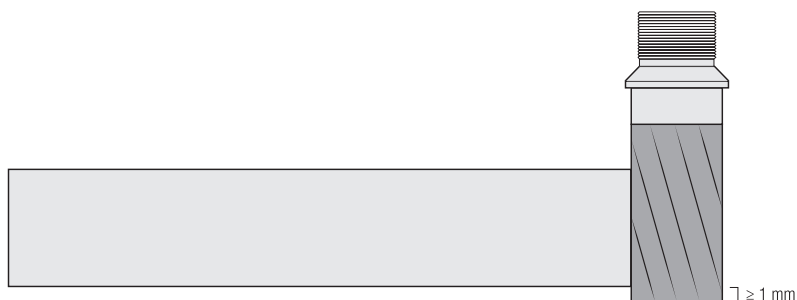
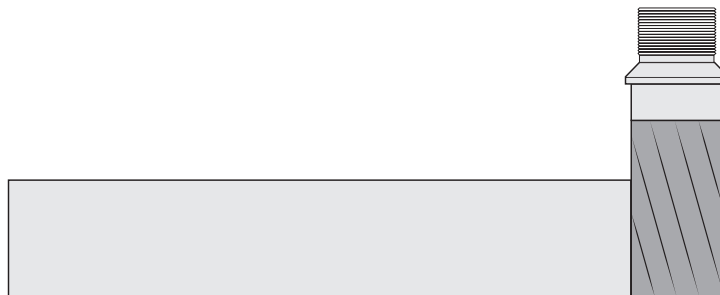

# Machining the edges

The edges of the MATERIA porcelain stoneware slabs can be machined in a CNC contouring machine in such a way so as to obtain various profiles. MATERIA recommends against leaving the slabs with a sharp edge and recommends carrying out a 1 mm minimum chamfer or a rounded profile with a 1 mm minimum radius of curvature. The edge of the slab can subsequently be subjected to grinding, including by polishing grinders. Below are a few examples that can be obtained using a CNC contouring machine.

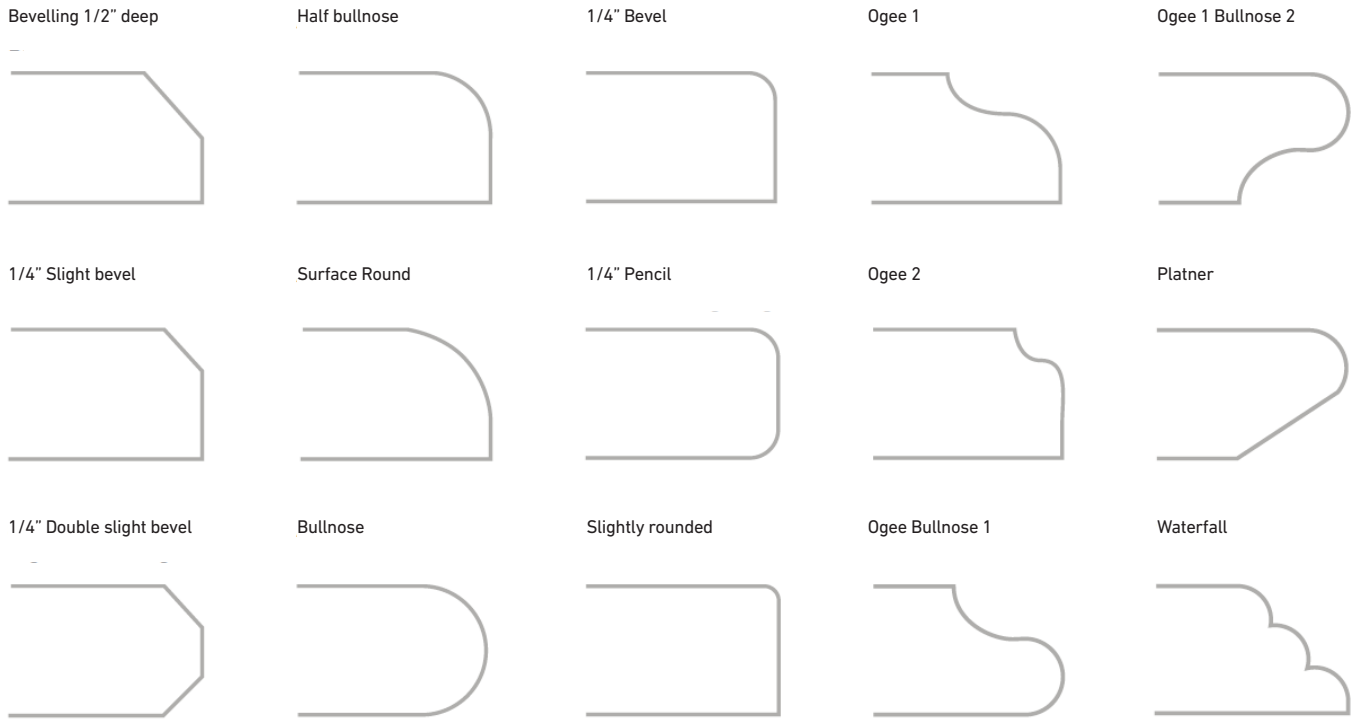

The perimeter profile of the slabs, but not that of the inside of the holes, can also be contoured using a straightline contouring machine like the ones used in the glass industry. In this case, without a CNC contouring machine, the edge of the hole must be machined with a manual diamond backing pad.

The straight-line contouring machine is also able to carry out the 45° cut of the edge on the perimeter of the surface.

# INSTALLING THE COUNTERTOP

MATERIA suggests handling the cut surface in a vertical position. In the event that the holes are arranged closer to one side, it is advisable to keep that side upward.

## Supports

The MATERIA slabs can be glued onto a full support as well as on reinforcements. In both cases, using elastic and deformable adhesives capable of overcoming the different thermal expansion of slab and support is advisable. Spreadable adhesives are also available on the market which guarantee adhesion on any type of support and good deformability. Gluing the slabs onto quartz agglomeration reinforcements is absolutely inadvisable.

In the case of gluing on reinforcements, ensure the optimal arrangement of the reinforcements in the most delicate points of the surface, such as the internal perimeter of the holes (sink, cooking surface, water mixing tap) and along the entire external perimeter.



— COUNTERTOP PERIMETER  
- - - SUPPORTS

The following is a list of the main types of existing supports.

- Wood.
- Glass and crystal.
- High density polystyrene.
- Extruded polystyrene.
- Marine plywood panels.
- Honeycomb aluminium sandwich panels.
- Stone.

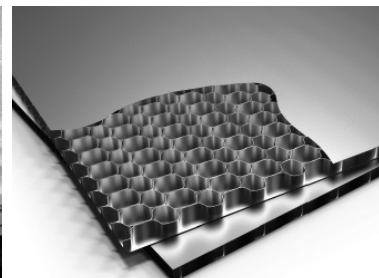
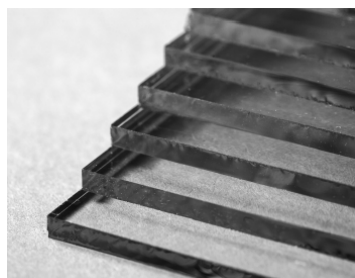

# Overhang parameters

Thickness 12 mm and 20 mm.

The maximum overhang the surface can sustain without having to provide an adequate support is 15 cm. The entity of static capacity (sustainable weight) is subordinate to whether or not there are holes in the immediate vicinity. We always recommend a specific assessment in that excessive weight near the holes can cause the surface to break. For overhangs greater than 15 cm, up to a maximum of 30 cm, an adequate support must be provided.

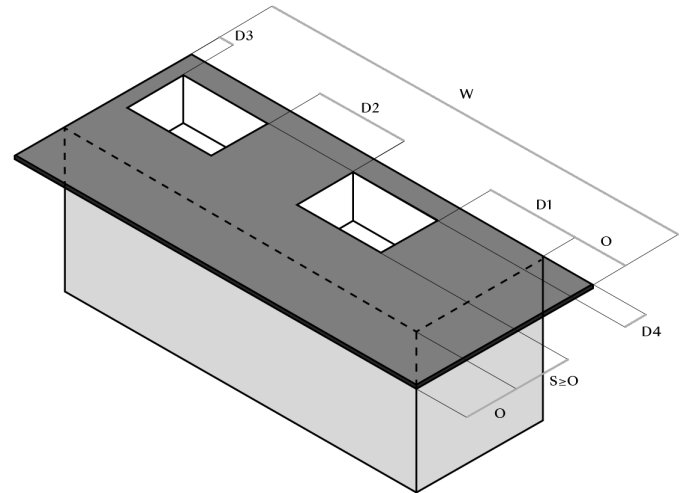
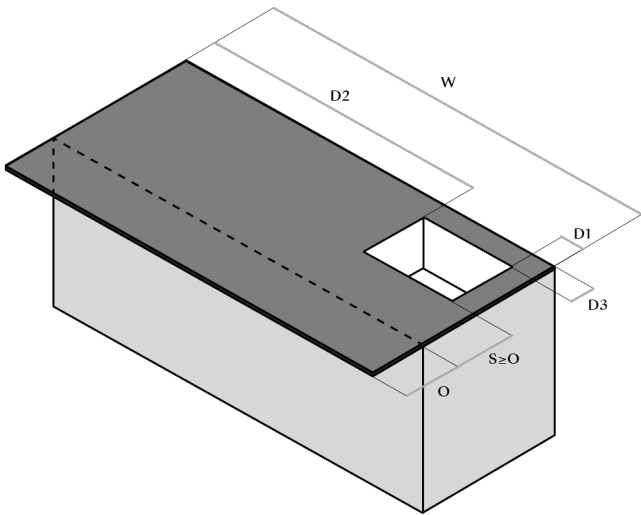

- $W \geq 600 \text{ mm}$
- O = Protruding wall
- S = Area with substrate
- $D1 \geq 100 \text{ mm}$
- $D2 \geq 100 \text{ mm}$
- $D3 \geq 100 \text{ mm}$
- $D1+D2 \geq 0$

- $W \geq 600 \text{ mm}$
- O = Protruding wall
- S = Area with substrate
- $D1 \geq 600 \text{ mm}$
- $D2 \geq 600 \text{ mm}$
- $D3 \geq 100 \text{ mm}$
- $D4 \geq 100 \text{ mm}$

For standard lengths that exceed an overhang of 30 cm, an adequate support must be provided from the bases, at least every 60-62 cm.

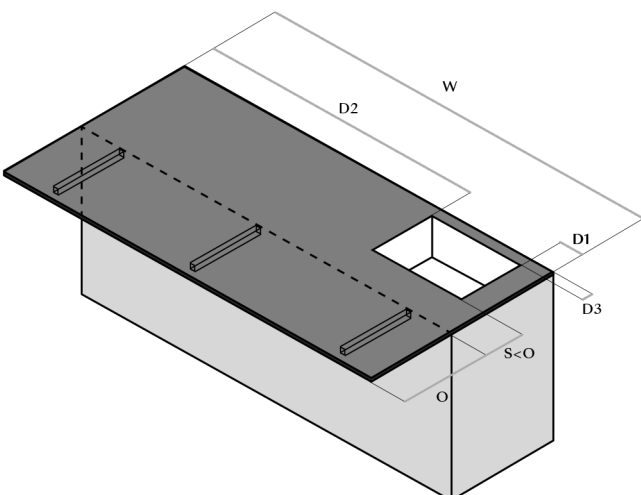

- $W \geq 600 \text{ mm}$
- O = Protruding wall
- S = Area with substrate
- $D1 \geq 100 \text{ mm}$
- $D2 \geq 100 \text{ mm}$
- $D3 \geq 50 \text{ mm}$
- $D1+D2 \geq 0$



# Coplanar slabs

If two or more coplanar slabs are to be placed next to one another due to the design of the kitchen countertop, as in the case of "L" shaped or "U" shaped kitchens, MATERIA recommends making a 1 mm chamfer on the coupled edges in order to avoid possible chipping when placing them next to one another.

In any case, levelling the support is indispensable also to guarantee the flatness of the upper surface of the two slabs.

Always provide a minimum joint (1 mm) in silicone or epoxy grout in a colour to match the slab, taking care to adequately clean the two surfaces that will come into contact with one another before applying adhesive.

We recommend to make a slight bevel on the edge also on the side that goes to the wall because it allows a better elasticity of the material in case of thermal expansion.

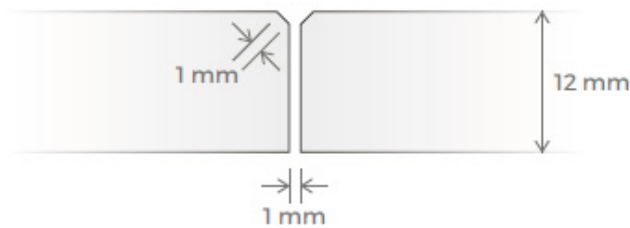

MATERIA recommends always leaving a margin of at least 2 mm between the slab of the countertop and the well in order to avoid any problems of flatness of the wall and thermal expansion of the countertop.

This margin can be covered using a riser.

Furthermore, in the case of a cooking surface or flush mounted sink, we recommend leaving 2 mm between the cooking surface/sink and the recess.

In both cases, MATERIA recommends filling the gap using silicone suitable for the use or gaskets provided by the cooking surface or sink manufacturer.

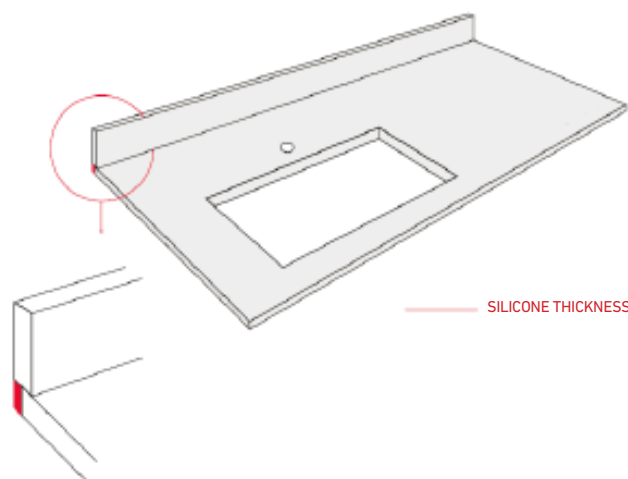



# Slabs handling

During transport it is fundamental to avoid shocks of the slabs, especially on the edges of the top.

We suggest to move the slab vertically without using the holes as support points in order to avoid cracks or breakages in these more delicate points.

We also suggest to cover the slab during the transport with wooden boxes or special tarpaulins, paying attention to properly protect edges and corners.

If the top includes the pre-assembled bathtub, it will have to be provided with a wooden box that has a support able to sustain the weight of the washbasin, so that it does not generate a torsion of the top.

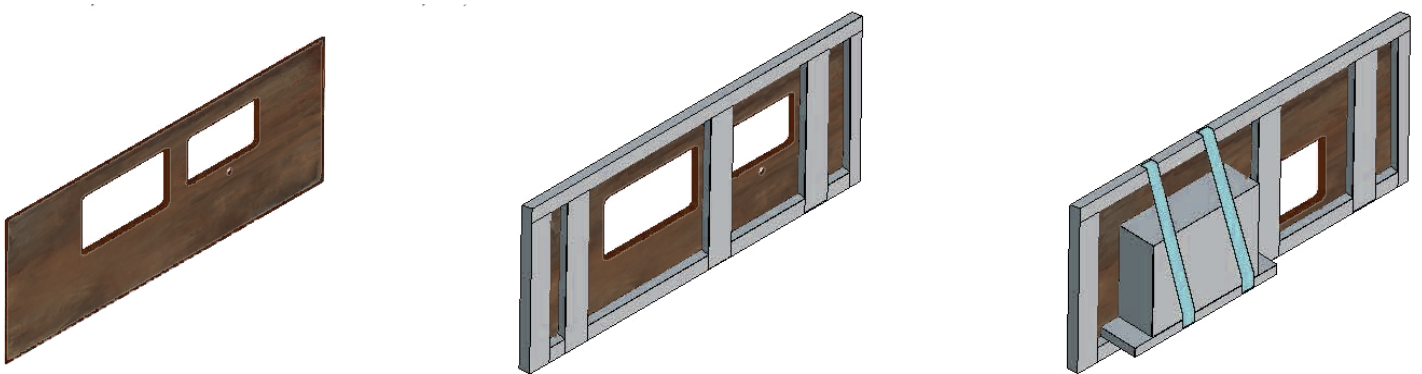

## 45° Joint

In the event that the project requires a filler or side, the slabs machined with a 45° cut are glued using specific adhesive, after which, the joint must be chamfered in order to reduce the sharp profile of the edge. However, it is also possible to carry out a slight chamfer on the two edges before gluing.

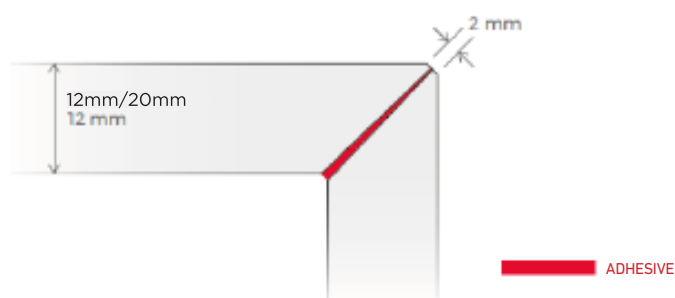

Before applying the adhesive, it is advisable to clean the edges and possibly treat them with acetone. The ideal adhesives for 45° gluing are the two-component epoxy type. The catalysis of these adhesives is the chemical type and requires a certain hardening time. The atmospheric temperature, as well as the temperature of the slabs, has an impact on the hardening time. It is advisable to carry out gluing at a temperature above 10°C. In any case, MATERIA suggests that you read the recommendations of the specific adhesive manufacturer carefully. It is important to remove excesses of adhesive before it hardens. Please see the cleaning and maintenance manual for cleaning tips. To create invisible joints, we recommend cutting each edge at an angle slightly greater than 45° in order to leave more space for the glue in the rear part of the joint. In the case of a 45° joint between slabs intended for outdoor use, and therefore subject to a different thermal expansion between the MATERIA surface and the support, we highly recommend using a support for the filler separated from the horizontal support by at least 5 mm. This cavity allows differential expansion between surface and support. Use suitable adhesive for outdoor applications, resistant to thermal shock, water and yellowing.

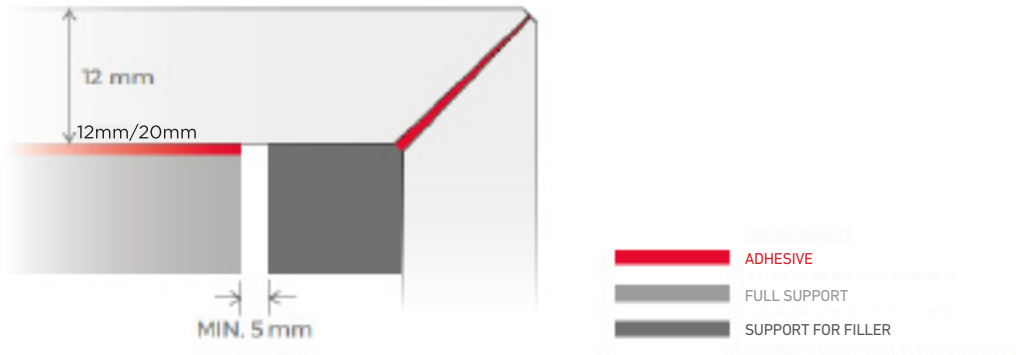

## Sinks

The MATERIA slabs can be combined with different types of sinks, such as drop-in sinks, undermount sinks and flush-mounted sinks.

We recommend following the sink manufacturer’s installation suggestions.

In the case of an undermount sink with a basin larger than the countertop hole, in order to reduce the risk of chipping, we recommend carrying out a 1 mm minimum chamfer or radius on the lower edge as well.

In the case of a flush-mounted sink, follow the cutting suggestions and provide a margin of at least 2 mm between the sink and the recess. In the case of medium and large size sinks, we recommend always using support brackets under the sink.

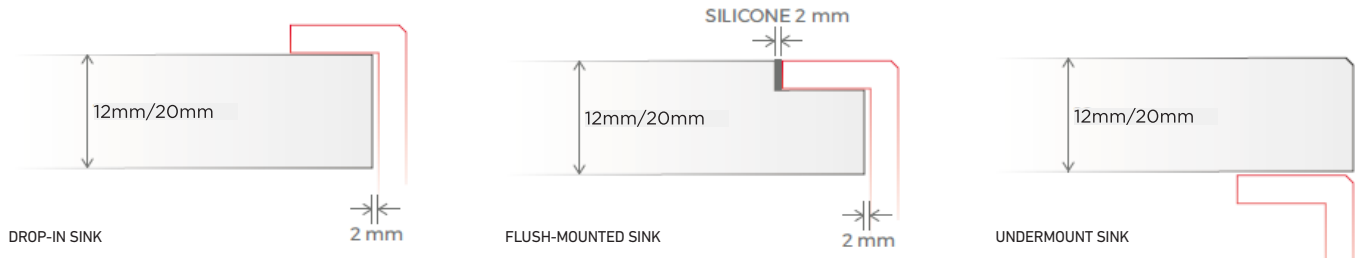

# Cleaning and maintenance

## Cleaning after installation

MATERIA products have a surface that's resistant to stains, hygienic and easy to maintain; to preserve these characteristics, thorough cleaning must occur as soon

as installation is completed, eliminating any residues that may create a film on the surface of the product capable of retaining more dirt. Insufficient or late removal of

grout, silicone and adhesive residues may leave stains that are difficult to remove.

Initial cleaning must therefore take place immediately after installation, using acid-based products, rubbing hard and rinsing well with plenty of water. This will permit

the elimination of adhesive, cement, silicone residues, etc. All detergents available on the market may be

used with the sole exception of products containing hydrofluoric acid (compounds and derivatives) as per the EN 14411 standard.

Per la rimozione dei residui di stucco epossidico si suggerisce l'uso di un detergente alcalino (es.: FILA CR10 - [filasolutions.com](http://filasolutions.com))

**NB:** Take care to follow the instructions provided by the producer on the pack of the product used. Before cleaning the surface installed, it is always best to test the cleaning agents first on a sample of the material which has not been installed, or on a small, not very visible area.

## Routine cleaning

For routine cleaning, it is enough to follow a few simple precautions which are mainly common sense once the material's characteristics are borne in mind.

- Use neutral, wax-free detergents diluted in water, always following the instructions on the packs.
- Clean water may be sufficient for frequent washes.
- Do not use acidic products or abrasive tools, which may make the surface of lapped materials matt, and compromise the cement-based materials used for sealing.
- All possible care should be taken to prevent the presence of material from outdoors which may cause scratches, quartz sand and other materials, since they may cause abrasion of the surface and reduce its shine.

### • VENTILATED FACADES

The insulation installed behind the slab covering is most effective when perfectly dry; do not use violent water jets.

We recommend the use of a neutral cleaner ( e.g.: [FILACLEANER](http://FILACLEANER) - [filasolutions.com](http://filasolutions.com))

**NB:** Waxes, oily soaps and impregnating materials (water and oil-repellents) should not be used on porcelain stoneware.

## Extraordinary cleaning

If the product requires extraordinary cleaning due to particularly stubborn stains, action should be taken as soon as possible, using the specific detergents recommended in the table below:

STAIN FOR REMOVAL	TYPE OF DETERGENT	RECOMMENDED CLEANERS
OIL AND GREASE	ALKALINE CLEANERS	FILA PS87 PRO
BEER		
CHEWING GUM		
VINYL GLUE		
TYRE MARKS		
SILICONE	ALKALINE STAIN-REMOVERS OR SOLVENTS	FILA ZERO SIL
POLYURETHANE FOAM		
ADHESIVE TAPE RESIDUES		
WAX PASTEL MARKS		
INK	ALKALINE STAIN-REMOVERS OR CLEANERS	FILA PS87 PRO - FILA SR95
NICOTINE		
URINE AND VOMIT		
MARKER PEN STAINS		
HAIR DYE		
COFFEE		
WINE		
BLOOD		
COCA COLA		
SUCTION-CUP MARKS	ALKALINE CLEANERS	FILA PS87 PRO - FILA CR10
RUST	ACID CLEANERS OR RUST CONVERTERS	DETERDEK PRO - FILA NO RUST
CEMENT-SALTPETRE	ACID CLEANERS OR ACID DESCALER	DETERDEK PRO - FILA PH ZERO
LIMESCALE		
ALUMINIUM - METAL MARKS		
PENCIL		
EPOXY FILLER	ALKALINE CLEANERS	FILA CR10
VARNISH - PAINT	ALKALINE PAINT STRIPPERS OR SOLVENTS	FILA NO PAINT STAR
GRAFFITI		
DIRTY GROUT LINES	ALKALINE CLEANERS	FUGANET
BITUMEN	SOLVENTS	FILA SOLV
CANDLE WAX		
ROUTINE MAINTENANCE	NEUTRAL CLEANERS	FILA CLEANER
SCRATCH REMOVER WAX	ALKALINE STAIN-REMOVERS OR SOLVENTS	FILA SOLV - FILA ZERO SIL

**NB:** On polished products, do not use acid cleaners at high concentrations. They should be diluted in water to 10-15%. Before any use of cleaners, it is important always to test them on part of the surface, especially on polished products. All cleaning products should be diluted with water.

## Technical characteristics

TECHNICAL CHARACTERISTICS	STANDARD	DESCRIPTION OF TEST METHOD	TEST RESULTS
Breaking strength in n (thk ≥ 7,5 mm: 1300 N   thk. < 7,5 mm: 700 N)	ISO 10545-4	Application of a load to the midline of the panel until breakage is obtained	Average value 6 mm: 1300 N Average value 12 mm: 12000 N Average value 20 mm: 20000 N
N/mm <sup>2</sup> flexural strenght test (≥ 35 N/mm <sup>2</sup> )			Average value 6 mm ≥ 40 N/mm <sup>2</sup> Average value 12 mm ≥ 47 N/mm <sup>2</sup> Average value 20 mm ≥ 50 N/mm <sup>2</sup>
Fire reaction	UNI EN 13501-1	Floor radiant panel test UNI EN ISO 9293-1	Classe A1 <sub>fl</sub> +A1
Impact resistance	UNI EN ISO 14617-9	Resistance to dropping a 1 kg steel ball on a sample placed on a bed of sand.	compliant
Coefficient of return	UNI EN ISO 10545-5	Measurement of 28 g steel ball rebound height.	compliant
Volatile organic compound emission tests	UNI EN ISO 16000-9	28 days length-test	compliant
Compression strength	ASTM C170M-16	Breaking load on 12x12x12 mm samples	compliant
Static load for raised floors	UNI EN ISO 12825	Application of increasing load until sample until breakage is obtained	compliant
Cadmium and lead release in mg/dm <sup>2</sup>	ISO 10545-15	Request for GL surfaces for work tops	none
Resistance to damp heat	UNI EN 12721:2013	55° to 100° cycles	compliant
Resistance to dry heat	UNI EN 12722:2013	55° to 100° cycles	compliant
Resistance to cold liquids	UNI EN 12720:2013	Period of contact 10s to 24 h	compliant
Tendency to retain dirt	UNI 9300:2015	Carbon black staining agent	No visible change
Scratch resistance	UNI EN 15186:2012 met.B	Load > 10N	compliant (Nat. + Soft Surface)
Fungi resistance	ASTM G 21-15	Contact for 28 days with a variety of fungal strains	compliant
valore di riflessione della luce light reflectance value lrv	Metodo di prova interno In-house test method	Illuminant D65 Illuminant A Spectrophotometer at 10°	Based on the colour: Available on request
Colours' resistance to fading	DIN 51094	Evaluation of the color changes following a 28 day exposure to ultra violet light.	compliant

TECHNICAL CHARACTERISTICS	STANDARD	STANDARD REQUIREMENTS		TEST RESULTS
		(%)	(mm)	
Admitted deviation, in %, of the average thickness of each tile from the production dimensions	ISO 10545-2	± 5%		± 5%
Flatness (curving in the middle, corner and warping)	ISO 10545-2	±0,5% ±2 mm		±0,5% mm
Surface quality	ISO 10545-2	At least 95% of the tiles must be free from visible flaws.		compliant
% Water absorption	ISO 10545-3	< 0,5%		< 0,5%
resistance to deep abrasion of unglazed tiles	ISO 10545-6	<175 mm <sup>3</sup>		compliant
Thermal shocks resistant	ISO 10545-9	available testing method		résistant
Resistance to staining	ISO 10545-14	see manufacturer's certificate		Classe 5 (Nat. + Soft) Classe 3-4 (Lux )
Resistance to low concentrations of acids and alkalis	ISO 10545-13	see manufacturer's certificate		ULA-ULB (Nat + Soft) UB (Lux )
Resistance to domestic chemical products and additives for swimming pools		MIN B		UA
Frost resistance	ISO 10545-12	required		résistant



## Comparative table

Porcelain slabs are a smart and safe choice for kitchen worktops. They have outstanding qualities and meet the most common parameters of durability and resistance used to evaluate materials in general.

	MATERIA NAT./SOFT	MATERIA LUX	Quartz agglomerates	Laminates and Wood	Solid surface	Natural Stones	Steel
Hygienic	■■■■	■■■■	■■■■	■	■■■■	■	■■■■
Non porous	■■■■	■■■■	■■■■	■	■■■■	■	■■■■
Suitable for use outdoors	■■■■	■■■■	■	■	■■	■■	■■
Resistant to heat and high temperatures	■■■■	■■■■	■■	■	■	■■	■■■■
Resistant to mould, mildew, and fungus	■■■■	■■■■	■■■■	■■	■■■■	■	■■■■
Stainproof	■■■■	■■	■■	■■	■■	■	■■■■
Detergent-resistant	■■■■	■■	■■	■■	■	■	■
Chemical resistance	■■■■	■■	■■	■	■■	■	■■
Resistance to thermal shock	■■■■	■■■■	■■	■	■■	■■■■	■■■■
Frost resistance	■■■■	■■■■	■■■■	■	■	■■	■■■■
Dampness resistance	■■■■	■■■■	■■■■	■	■■■■	■	■■■■
UV-resistant	■■■■	■■■■	■■	■	■	■■	■■■■
Scratchproof and abrasion-resistant	■■■■	■■	■■	■	■	■■	■
Easy to clean	■■■■	■■■■	■■■■	■■	■■	■	■

## Packaging

### 1635x3230 mm

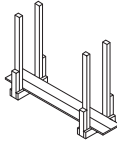
	Nominal size	Work size	Thickness	Type of packing	Slabs/Packing	Sqm total	kg/slab	Kg/Packing	Kg total
	nat / soft / lux 1635x3230 mm	nat / soft / lux 1635x3230 mm	6 mm	Crate	15	76,80	76	139	1.279
	nat / soft 1635x3230 mm	nat / soft 1635x3230 mm	12 mm	Crate	10	51,20	152	139	1.659
	lux 1635x3230 mm	lux 1635x3230 mm	12 mm	Crate	9	46,08	152	139	1.507
	nat / soft / lux 1635x3230 mm	nat / soft / lux 1635x3230 mm	20 mm	Crate	5	25,60	246	139	1.369
	nat / soft / lux 1635x3230 mm	nat / soft / lux 1635x3230 mm	6 mm	Container Rack pallet wood A - frame	36	184,32	76	180	2.916
	nat / soft / lux 1635x3230 mm	nat / soft / lux 1635x3230 mm	12 mm	Container Rack pallet wood A - frame	22 *18	112,64 92,16	152	180	3.524 2.916
	nat / soft / lux 1635x3230 mm	nat / soft / lux 1635x3230 mm	20 mm	Container Rack pallet wood A - frame	12 *10	61,44 51,20	246	180	3.132 2.640
	nat / soft / lux 1635x3230 mm	nat / soft / lux 1635x3230 mm	6 mm	Container Rack pallet metal A - frame	36	184,32	76	180	2.916
	nat / soft / lux 1635x3230 mm	nat / soft / lux 1635x3230 mm	12 mm	Container Rack pallet metal A - frame	22 *18	112,64 92,16	152	180	3.524
	nat / soft / lux 1635x3230 mm	nat / soft / lux 1635x3230 mm	20 mm	Container Rack pallet metal A - frame	12 *10	61,44 51,20	246	180	3.132 2.640
	nat / soft / lux 1635x3230 mm	nat / soft / lux 1635x3230 mm	6 mm	Bundle	27	138,24	76	60	2.112
	nat / soft / lux 1635x3230 mm	nat / soft / lux 1635x3230 mm	12 mm	Bundle	18	92,16	152	60	2.796
	nat / soft / lux 1635x3230 mm	nat / soft / lux 1635x3230 mm	20 mm	Bundle	12	61,44	246	60	3.012

\* A Frame for container loading contains 18 slabs in 12 mm thickness and not 22, 10 slabs in 20 mm thickness and not 12.

Crate  
Stackable

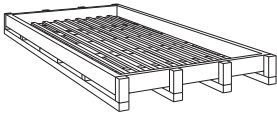

Size 174x345x27,5

Container Rack pallet wood A - frame  
Not stackable

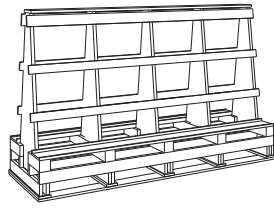

Size 75x330x201

Container Rack pallet metal A - frame

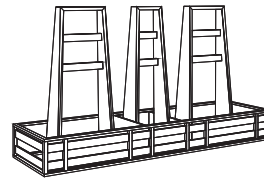

Size 75x330x201

Bundle

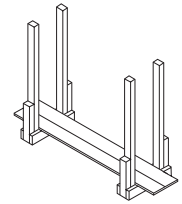

Size 54x330x223

	Slab thickness	Packaging quantity	Slabs total	Sqm total	kg/slab	Kg/packing	Kg total	
CONTAINER 20"	6 mm nat / soft / lux	nr. 3 container rack pallet wood A - frame	108	552,96	76	540	8.748	
		nr. 5 crates	75	384,00	76	834	6.534	
		8 bundles	216	1105,92	76	480	16.896	
	12 mm soft / nat	nr. 3 container rack pallet wood A - frame	54	276,48	152	540	8.748	
		nr. 5 crates	50	256,00	152	834	8.434	
		8 bundles	144	737,28	152	480	22.368	
	12 mm lux	nr. 3 container rack pallet wood A - frame	54	276,48	152	540	8.748	
		nr. 5 crates	45	230,40	152	834	7.674	
		8 bundles	144	737,28	152	480	22.368	
	20 mm nat / soft / lux	nr. 3 container rack pallet wood A - frame	30	153,60	250	540	8.040	
		nr. 5 crates	25	128,00	250	695	6.945	
		8 bundles	96	491,52	250	480	24.480	
CONTAINER 40"	6 mm nat / soft / lux	nr. 8 container rack pallet wood A - frame	288	1.474,56	76	1.440	23.328	
		nr. 15 crates	225	1.152,00	76	2.502	19.602	
	12 mm nat / soft	nr. 9 container rack pallet wood A - frame	162	829,44	152	1.440	26.064	
		nr. 15 crates	150	768,00	152	2.502	25.302	
	12 mm lux	nr. 9 container rack pallet wood A - frame	162	829,44	152	1.440	26.064	
		nr. 15 crates	135	691,20	152	2.502	23.022	
	20 mm nat / soft / lux	nr. 9 container rack pallet wood A - frame	90	460,80	250	1.620	24.120	
		nr. 15 crates	75	384,00	250	2.085	20.835	
	CAMION	6 mm nat / soft / lux	nr. 9 container rack pallet wood A - frame	324	1.658,88	76	1.620	26.244
			nr. 12 crates	180	921,60	76	1.668	15.348
		12 mm nat / soft	nr. 8 container rack pallet wood A - frame	176	901,12	152	1.440	28.192
			nr. 12 crates	120	614,40	152	1.668	19.908
12 mm lux		nr. 8 container rack pallet wood A - frame	176	901,12	152	1.440	28.192	
		nr. 12 crates	108	552,96	152	1.668	18.084	
20 mm nat / soft / lux		nr. 9 container rack pallet wood A - frame	108	552,96	250	1.620	28.620	
		nr. 12 crates	60	307,20	250	1.668	16.668	

MA  
TER  
IA™